

Article properties

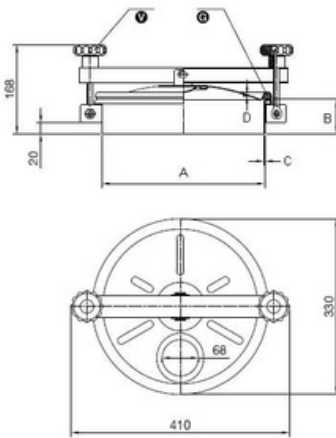

Article	9402.218 Round Inspection Cover 218 Cover
Description	opening outwards Material: 1.4307 (304L) Pressure range: +0,2 bar Outside Neck diameter: Ø306mm Tolerance ISO2768 cL: ±1.2mm Welding Neck height: 200mm Welding Neck thickness: 2,0mm Cover thickness: 1,2mm 2x Plastic Handwheel MEC/60 EPDM gasket (FDA)G/TR300 Finish Neck: Grinded/Pickled Finish Cover: Electropolished
Name	218 (Neck 200x2) 304
Type	215
DN	DN300
A	306
B	200
C	2
D	1,2
E	0,2 bar

Round Inspection Cover 218 Cover opening outwards Material: 1.4307 (304L) Pressure range: +0,2 bar Outside Neck diameter: Ø306mm Tolerance ISO2768 cL: ±1.2mm Welding Neck height: 200mm Welding Neck thickness: 2,0mm Cover thickness: 1,2mm 2x Plastic Handwheel MEC/60 EPDM gasket (FDA)G/TR300 Finish Neck: Grinded/Pickled Finish Cover: Electropolished