

Article properties

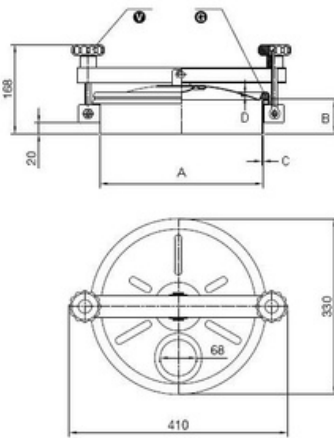

Article	9402.218B Round Inspection Cover 218/B Cover
Description	opening outwards Material: 1.4404 (316L) Pressure range: +0,2 bar Outside Neck diameter: Ø306mm Tolerance ISO2768 cL: ±1.2mm Welding Neck height: 200mm Welding Neck thickness: 2,0mm Cover thickness: 1,2mm 2x Plastic Handwheel MEC/60 EPDM gasket (FDA)G/TR300 Finish Neck: Grinded/Pickled Finish Cover: Electropolished
Name	218/B (Neck 200x2) 316
Type	215
DN	DN300
A	306
B	200
C	2
D	1,2
E	0,2 bar

Round Inspection Cover 218/B Cover opening outwards Material: 1.4404 (316L) Pressure range: +0,2 bar Outside Neck diameter: Ø306mm Tolerance ISO2768 cL: ±1.2mm Welding Neck height: 200mm Welding Neck thickness: 2,0mm Cover thickness: 1,2mm 2x Plastic Handwheel MEC/60 EPDM gasket (FDA)G/TR300 Finish Neck: Grinded/Pickled Finish Cover: Electropolished