

## Article properties

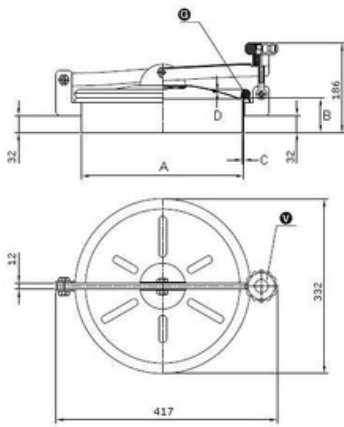

Article	9402.242B Round Inspection Cover 242B Cover
Description	opening outwards Material: 1.4404 (316L) Pressure range: +0,1 bar Outside Neck diameter: Ø306mm Tolerance ISO2768 cL: ±1.2mm Welding Neck height: 150mm Welding Neck thickness: 2,0mm Cover thickness: 1,2mm 1x Plastic Handwheel MEC/60 EPDM gasket (FDA)G/TR300 Finish Neck: Grinded/Pickled Finish Cover: Electropolished
Name	242/B (Neck 150x2) 316
Type	240
DN	DN300
A	306
B	150
C	2
D	1,2
E	0,1 bar

Round Inspection Cover 242B Cover opening outwards Material: 1.4404 (316L) Pressure range: +0,1 bar Outside Neck diameter: Ø306mm Tolerance ISO2768 cL: ±1.2mm Welding Neck height: 150mm Welding Neck thickness: 2,0mm Cover thickness: 1,2mm 1x Plastic Handwheel MEC/60 EPDM gasket (FDA)G/TR300 Finish Neck: Grinded/Pickled Finish Cover: Electropolished