

Article properties

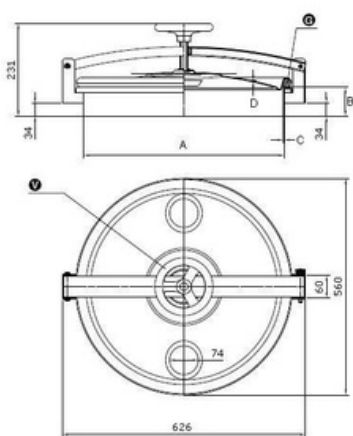

Article	9402.272 Round Inspection Cover 272 Cover
Description	opening outwards Material: 1.4307 (304L) Pressure range: +0,1 bar Outside Neck diameter: Ø518mm Tolerance ISO2768 cL: ±2.0mm Welding Neck height: 150mm Welding Neck thickness: 3,0mm Cover thickness: 2,0mm 1x Plastic Handwheel MEC/151 EPDM gasket (FDA) G/TR500 Finish Neck: Grinded/Pickled Finish Cover: Electropolished 272 (Neck 150x3) 304
Name	270
Type	DN500
DN	518
A	150
B	3
C	2
D	0,0 bar
E	

Round Inspection Cover 272 Cover opening outwards Material: 1.4307 (304L) Pressure range: +0,1 bar Outside Neck diameter: Ø518mm Tolerance ISO2768 cL: ±2.0mm Welding Neck height: 150mm Welding Neck thickness: 3,0mm Cover thickness: 2,0mm 1x Plastic Handwheel MEC/151 EPDM gasket (FDA) G/TR500 Finish Neck: Grinded/Pickled Finish Cover: Electropolished