

Article properties

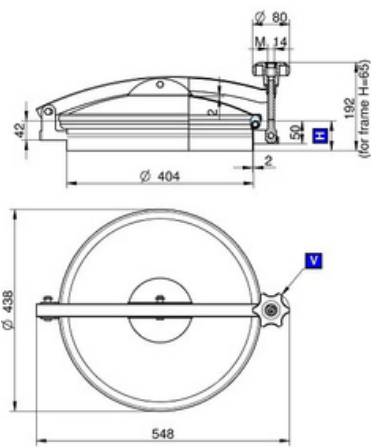

Article	9402.401/AZ-GN Round Manhole Cover 401/AZ-
Description	GN Opening outwards: hinge/swivel Material: 1.4307 (304L) Pressure range: -0,7/+0,05 bar Outside Neck diameter: $\varnothing 404$ mm Tolerance: ISO2768 cL: ± 2.0 mm Welding Neck height: 100mm Welding Neck thickness: 2,0mm Cover thickness: 2,0mm 1x Plastic Handwheel MEC/80/A EPDM gasket (FDA) 400AZ/GN Finish Neck: Grinded/Pickled Finish Cover: Electropolished 401/AZ-GN (Neck 100x2)
Name	304 1.4307 400/AZ DN400 100 2 2 0,05 bar

Material

Type

DN

B

C

D

E

Round Manhole Cover 401/AZ-GN Opening outwards: hinge/swivel Material: 1.4307 (304L) Pressure range: -0,7/+0,05 bar Outside Neck diameter: $\varnothing 404$ mm Tolerance: ISO2768 cL: ± 2.0 mm Welding Neck height: 100mm Welding Neck thickness: 2,0mm Cover thickness: 2,0mm 1x Plastic Handwheel MEC/80/A EPDM gasket (FDA) 400AZ/GN Finish Neck: Grinded/Pickled Finish Cover: Electropolished