

Article properties

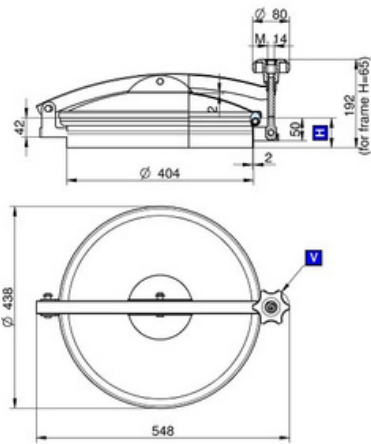

Article	9402.401/AZ-NL
Description	Round Manhole Cover 401/AZ-NL Opening outwards: hinge/swivel Material: 1.4307 (304L) Pressure range: pressureless Outside Neck diameter: $\varnothing 404$ mm Tolerance: ISO2768 cL: ± 2.0 mm Welding Neck height: 100mm Welding Neck thickness: 2,0mm Cover thickness: 2,0mm 1x Plastic Handwheel MEC/80/A EPDM gasket (FDA) 400AZ/NL Finish Neck: Grinded/Pickled Finish Cover: Electropolished 401/AZ-NL (Neck 100x2) 304
Name	400/AZ
Type	DN400
DN	404
A	100
B	2
C	2
D	0,05 bar
E	

Round Manhole Cover 401/AZ-NL Opening outwards: hinge/swivel Material: 1.4307 (304L) Pressure range: pressureless Outside Neck diameter: $\varnothing 404$ mm Tolerance: ISO2768 cL: ± 2.0 mm Welding Neck height: 100mm Welding Neck thickness: 2,0mm Cover thickness: 2,0mm 1x Plastic Handwheel MEC/80/A EPDM gasket (FDA) 400AZ/NL Finish Neck: Grinded/Pickled Finish Cover: Electropolished