

Article properties

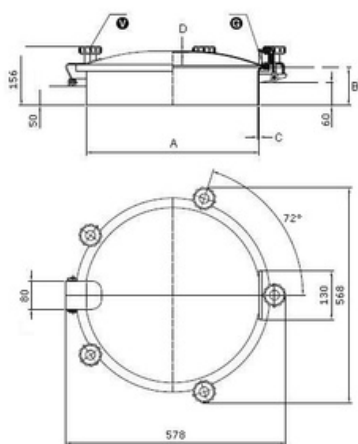

Article	9402.5V452B
Description	Round Manhole Cover 5V/452/B Cover opening outwards Material: 1.4404 (316L) Pressure range: +0,5 bar Outside Neck diameter: Ø454mm Tolerance ISO2768 cL: ±2.0mm Welding Neck height: 200mm Welding Neck thickness: 3,0mm Cover thickness: 2,0mm 5x Plastic Handwheel MEC/60 EPDM gasket (FDA) G/T450 Finish Neck: Grinded/Pickled Finish Cover: Electropolished
Name	5V/452/B (Neck 200x3) 316
Name	5V/450
Type	DN450
DN	454
A	200
B	3
C	2
D	0,5 bar
E	

Round Manhole Cover 5V/452/B Cover opening outwards Material: 1.4404 (316L) Pressure range: +0,5 bar Outside Neck diameter: Ø454mm Tolerance ISO2768 cL: ±2.0mm Welding Neck height: 200mm Welding Neck thickness: 3,0mm Cover thickness: 2,0mm 5x Plastic Handwheel MEC/60 EPDM gasket (FDA) G/T450 Finish Neck: Grinded/Pickled Finish Cover: Electropolished