

Article properties

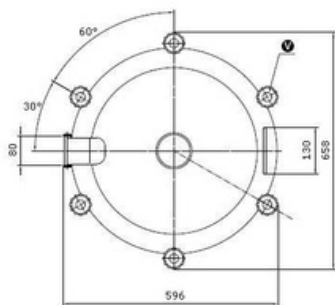
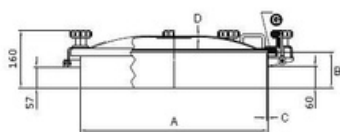

Article	9402.6V502
Description	Round Manhole Cover 6V/502 Cover opening outwards Material: 1.4307 (304L) Pressure range: +0,5 bar Outside Neck diameter: Ø518mm Tolerance ISO2768 cL: ±2.0mm Welding Neck height: 200mm Welding Neck thickness: 3,0mm Cover thickness: 3,0mm 6x Plastic Handwheel MEC/60 EPDM gasket (FDA) G/T500 Finish Neck: Grinded/Pickled Finish Cover: Electropolished
Name	6V/502 (Neck 200x3) 304
Type	6V/500
Type	DN500
DN	518
A	200
B	3
C	3
D	0,5 bar
E	

Round Manhole Cover 6V/502 Cover opening outwards Material: 1.4307 (304L) Pressure range: +0,5 bar Outside Neck diameter: Ø518mm Tolerance ISO2768 cL: ±2.0mm Welding Neck height: 200mm Welding Neck thickness: 3,0mm Cover thickness: 3,0mm 6x Plastic Handwheel MEC/60 EPDM gasket (FDA) G/T500 Finish Neck: Grinded/Pickled Finish Cover: Electropolished