

Article properties

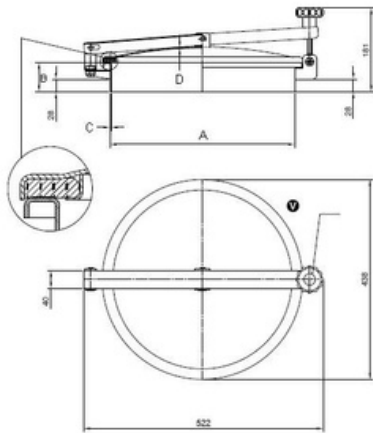

Article	9402.N242B Round Manhole Cover N/242/B
Description	Opening outwards: hinge/swivel Material: 1.4404 (316L) Pressure range: pressureless Outside Neck diameter: Ø404mm Tolerance ISO2768 cL: ±2.0mm Welding Neck height: 150mm Welding Neck thickness: 2,0mm Cover thickness: 2,0mm 1x Plastic Handwheel MEC/60 EPDM gasket (FDA)G/NL250 Finish Neck: Grinded/Pickled Finish Cover: Electropolished N/242/B (Neck 150x2) 316
Name	N/240
Type	DN400
DN	404
A	150
B	2
C	2
D	0,0 bar
E	

Round Manhole Cover N/242/B Opening outwards: hinge/swivel Material: 1.4404 (316L) Pressure range: pressureless Outside Neck diameter: Ø404mm Tolerance ISO2768 cL: ±2.0mm Welding Neck height: 150mm Welding Neck thickness: 2,0mm Cover thickness: 2,0mm 1x Plastic Handwheel MEC/60 EPDM gasket (FDA)G/NL250 Finish Neck: Grinded/Pickled Finish Cover: Electropolished