

Article properties

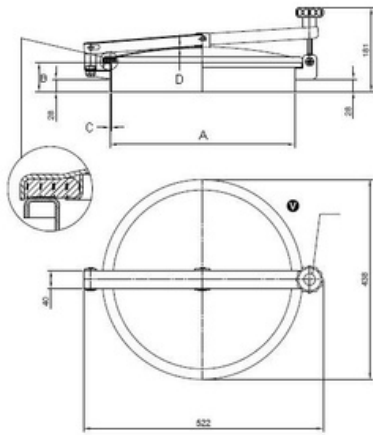

Article	9402.N243 Round Manhole Cover N/243 Opening
Description	outwards: hinge/swivel Material: 1.4307 (304L) Pressure range: pressureless Outside Neck diameter: Ø404mm Tolerance ISO2768 cL: ±2.0mm Welding Neck height: 200mm Welding Neck thickness: 2,0mm Cover thickness: 2,0mm 1x Plastic Handwheel MEC/60 EPDM gasket (FDA)G/NL250 Finish Neck: Grinded/Pickled Finish Cover: Electropolished N/243 (Neck 200x2) 304
Name	N/240
Type	DN400
DN	404
A	200
B	2
C	2
D	0,0 bar
E	

Round Manhole Cover N/243 Opening outwards: hinge/swivel Material: 1.4307 (304L) Pressure range: pressureless Outside Neck diameter: Ø404mm Tolerance ISO2768 cL: ±2.0mm Welding Neck height: 200mm Welding Neck thickness: 2,0mm Cover thickness: 2,0mm 1x Plastic Handwheel MEC/60 EPDM gasket (FDA)G/NL250 Finish Neck: Grinded/Pickled Finish Cover: Electropolished