

Article properties

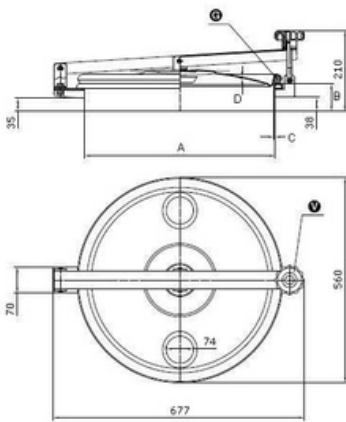

Article	9402.N273 Round Manhole Cover N/273 Opening
Description	outwards: hinge/swivel Material: 1.4307 (304L) Pressure range: +0,1 bar Outside Neck diameter: Ø518mm Tolerance ISO2768 cL: ±2.0mm Welding Neck height: 200mm Welding Neck thickness: 3,0mm Cover thickness: 2,0mm 1x Plastic Handwheel MEC/80/A EPDM gasket (FDA) G/TR500 Finish Neck: Grinded/Pickled Finish Cover: Electropolished N/273 (Neck 200x3) 304
Name	N/270
Type	DN500
DN	518
A	200
B	3
C	2
D	0,1 bar
E	

Round Manhole Cover N/273 Opening outwards: hinge/swivel Material: 1.4307 (304L) Pressure range: +0,1 bar Outside Neck diameter: Ø518mm Tolerance ISO2768 cL: ±2.0mm Welding Neck height: 200mm Welding Neck thickness: 3,0mm Cover thickness: 2,0mm 1x Plastic Handwheel MEC/80/A EPDM gasket (FDA) G/TR500 Finish Neck: Grinded/Pickled Finish Cover: Electropolished