

Article properties

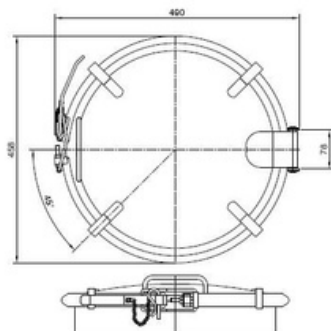
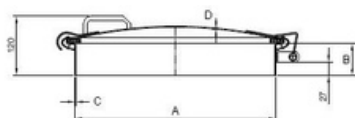

Article	9402.NL250B
Description	Round Manhole Cover NL/250/B With clamping ring Cover opening outwards Material: 1.4404 (316L) Pressure range: +1,0 bar Outside Neck diameter: Ø404mm Tolerance ISO2768 cL: ±2.0mm Welding Neck height: 65mm Welding Neck thickness: 2,0mm Cover thickness: 2,0mm EPDM gasket (FDA) G/NL250 Finish Neck: Grinded/Pickled Finish Cover: Electropolished NL/250/B (Neck 65x2) 316
Name	NL/250
Type	DN400
DN	404
A	65
B	2
C	2
D	1,0 bar
E	

Round Manhole Cover NL/250/B With clamping ring Cover opening outwards Material: 1.4404 (316L)
Pressure range: +1,0 bar Outside Neck diameter: Ø404mm Tolerance ISO2768 cL: ±2.0mm Welding
Neck height: 65mm Welding Neck thickness: 2,0mm Cover thickness: 2,0mm EPDM gasket (FDA)
G/NL250 Finish Neck: Grinded/Pickled Finish Cover: Electropolished