

Article properties

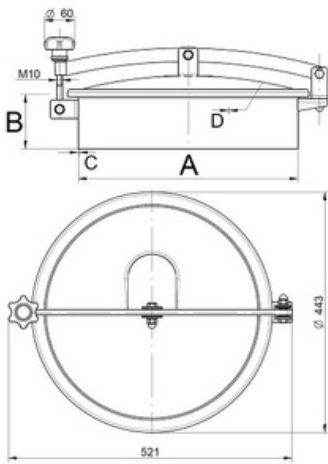

Article	9402.T1/403B Round Inspection Cover T1/403B
Description	Opening outwards: hinge/swivel Material: 1.4404 (316L) Pressure range: pressureless Outside Neck diameter: Ø404mm Tolerance: ISO2768 cL: ±2.0mm Welding Neck height: 200mm Welding Neck thickness: 2,0mm Cover thickness: 2,0mm 1x Plastic Handwheel MEC/60 EPDM gasket (FDA)G/T400 Finish Neck: Grinded/Pickled Finish Cover: Electropolished T1/400
Type	DN400
DN	404
A	200
B	2
C	2
D	0,0 bar
E	

Round Inspection Cover T1/403B Opening outwards: hinge/swivel Material: 1.4404 (316L) Pressure range: pressureless Outside Neck diameter: Ø404mm Tolerance: ISO2768 cL: ±2.0mm Welding Neck height: 200mm Welding Neck thickness: 2,0mm Cover thickness: 2,0mm 1x Plastic Handwheel MEC/60 EPDM gasket (FDA)G/T400 Finish Neck: Grinded/Pickled Finish Cover: Electropolished