

Article properties

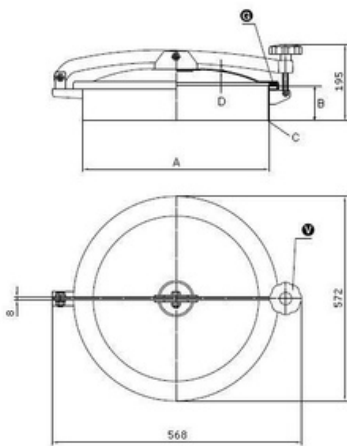

Article	9402.T1/502 Round Manhole Cover T1/502
Description	Opening outwards: hinge/swivel Material: 1.4307 (304L) Pressure range: pressureless Outside Neck diameter: Ø518mm Tolerance: ISO2768 cL: ±2.0mm Welding Neck height: 200mm Welding Neck thickness: 3,0mm Cover thickness: 3,0mm 1x Stainless T-Handle VI/165/A EPDM gasket (FDA) G/T500 Finish Neck: Grinded/Pickled Finish Cover: Electropolished T1/502 (Neck 200x3) 304
Name	T1/500
Type	DN500
DN	518
A	200
B	3
C	3
D	0,0 bar
E	

Round Manhole Cover T1/502 Opening outwards: hinge/swivel Material: 1.4307 (304L) Pressure range: pressureless Outside Neck diameter: Ø518mm Tolerance: ISO2768 cL: ±2.0mm Welding Neck height: 200mm Welding Neck thickness: 3,0mm Cover thickness: 3,0mm 1x Stainless T-Handle VI/165/A EPDM gasket (FDA) G/T500 Finish Neck: Grinded/Pickled Finish Cover: Electropolished