

Article properties

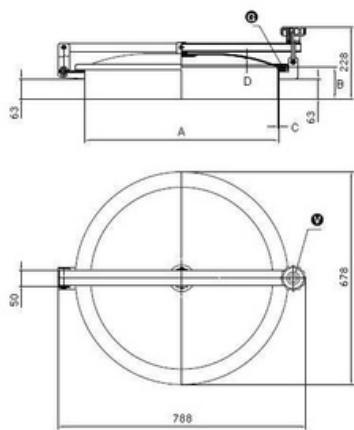

Article	9402.T1/602
Description	Round Manhole Cover T1/602 Opening outwards Material: 1.4307 (304L) Pressure range: pressureless Outside Neck diameter: Ø620mm Tolerance: ISO2768 cL: ±2.0mm Welding Neck height: 200mm Welding Neck thickness: 3,0mm Cover thickness: 3,0mm 1x Stainless T-Handle VI/165/A EPDM gasket (FDA) G/T600 Finish Neck: Grinded/Pickled Finish Cover: Electropolished T1/602 (Neck 200x3) 304
Name	T1/600
Type	DN600
DN	620
A	200
B	3
C	3
D	0,0 bar
E	

Round Manhole Cover T1/602 Opening outwards Material: 1.4307 (304L) Pressure range: pressureless Outside Neck diameter: Ø620mm Tolerance: ISO2768 cL: ±2.0mm Welding Neck height: 200mm Welding Neck thickness: 3,0mm Cover thickness: 3,0mm 1x Stainless T-Handle VI/165/A EPDM gasket (FDA) G/T600 Finish Neck: Grinded/Pickled Finish Cover: Electropolished