

### Article properties

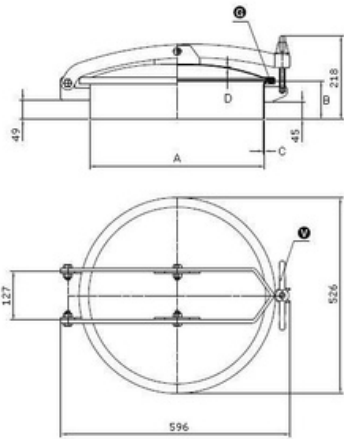

Article	9402.T451 Round Manhole Cover T/451 Cover
Description	opening outwards Hinge with double bracket Material: 1.4307 (304L) Pressure range: +0,1 bar Outside Neck diameter: Ø454mm Tolerance: ISO2768 cL: ±2.0mm Welding Neck height: 150mm Welding Neck thickness: 3,0mm Cover thickness: 2,0mm 1x Stainless T-Handle VI/165/A EPDM gasket (FDA) G/T450 Finish Neck: Grinded/Pickled Finish Cover: Electropolished T/451 (Neck 150x3) 304 T/450 DN450 454 150 3 2 0,1 bar

Name	
Type	
DN	
A	
B	
C	
D	
E	

Round Manhole Cover T/451 Cover opening outwards Hinge with double bracket Material: 1.4307 (304L) Pressure range: +0,1 bar Outside Neck diameter: Ø454mm Tolerance: ISO2768 cL: ±2.0mm Welding Neck height: 150mm Welding Neck thickness: 3,0mm Cover thickness: 2,0mm 1x Stainless T-Handle VI/165/A EPDM gasket (FDA) G/T450 Finish Neck: Grinded/Pickled Finish Cover: Electropolished