

Article properties

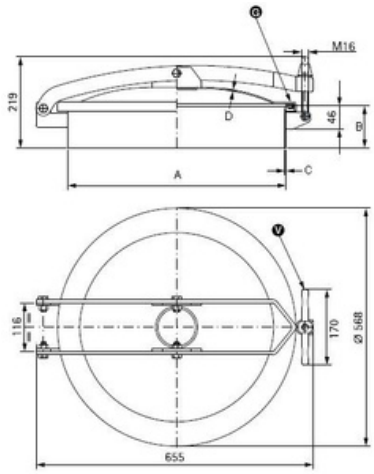

Article	9402.T501B Round Manhole Cover T/501/B Cover
Description	opening outwards Hinge with double bracket Material: 1.4404 (316L) Pressure range: +0,1 bar Outside Neck diameter: Ø518mm Tolerance: ISO2768 cL: ±2.0mm Welding Neck height: 100mm Welding Neck thickness: 3,0mm Cover thickness: 3,0mm 1x Stainless T-Handle VI/165/A EPDM gasket (FDA) G/T500 Finish Neck: Grinded/Pickled Finish Cover: Electropolished T/501/B (Neck 150x3) 316 T/500
Name	DN500 518 150 3 3 0,1 bar

Type	
DN	
A	
B	
C	
D	
E	

Round Manhole Cover T/501/B Cover opening outwards Hinge with double bracket Material: 1.4404 (316L) Pressure range: +0,1 bar Outside Neck diameter: Ø518mm Tolerance: ISO2768 cL: ±2.0mm Welding Neck height: 100mm Welding Neck thickness: 3,0mm Cover thickness: 3,0mm 1x Stainless T-Handle VI/165/A EPDM gasket (FDA) G/T500 Finish Neck: Grinded/Pickled Finish Cover: Electropolished