

### Article properties

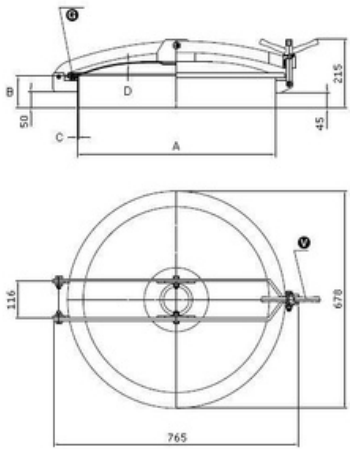

Article	9402.T602B Round Manhole Cover T/602/B Cover
Description	opening outwards Hinge with double bracket Material: 1.4404 (316L) Pressure range: pressureless Outside Neck diameter: Ø620mm Tolerance: ISO2768 cL: ±2.0mm Welding Neck height: 200mm Welding Neck thickness: 3,0mm Cover thickness: 3,0mm 1x Stainless T-Handle VI/165/A EPDM gasket (FDA) G/T600 Finish Neck: Grinded/Pickled Finish Cover: Electropolished T/602/B (Neck 200x3) 316 T/600
Name	DN600 620 200 3 3 0,0 bar

Type	
DN	
A	
B	
C	
D	
E	

Round Manhole Cover T/602/B Cover opening outwards Hinge with double bracket Material: 1.4404 (316L) Pressure range: pressureless Outside Neck diameter: Ø620mm Tolerance: ISO2768 cL: ±2.0mm Welding Neck height: 200mm Welding Neck thickness: 3,0mm Cover thickness: 3,0mm 1x Stainless T-Handle VI/165/A EPDM gasket (FDA) G/T600 Finish Neck: Grinded/Pickled Finish Cover: Electropolished