

Article properties

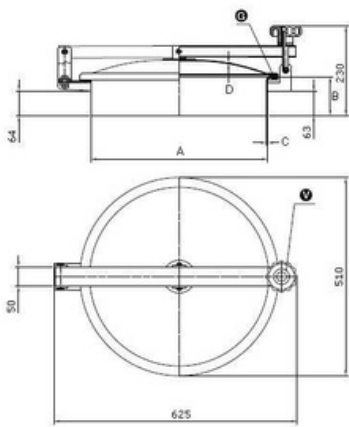

Article	9402.TV450B
Description	Round Manhole Cover TV/450/B Opening outwards: hinge/swivel Material: 1.4404 (316L) Pressure range: pressureless Outside Neck diameter: Ø454mm Tolerance: ISO2768 cL: ±2.0mm Welding Neck height: 100mm Welding Neck thickness: 3,0mm Cover thickness: 2,0mm 1x Plastic Handwheel MEC/80/A EPDM gasket (FDA) G/T450 Finish Neck: Grinded/Pickled Finish Cover: Electropolished TV/450/B (Neck 100x3) 316
Name	TV/450
Type	DN450
DN	454
A	100
B	3
C	2
D	0,0 bar
E	

Round Manhole Cover TV/450/B Opening outwards: hinge/swivel Material: 1.4404 (316L) Pressure range: pressureless Outside Neck diameter: Ø454mm Tolerance: ISO2768 cL: ±2.0mm Welding Neck height: 100mm Welding Neck thickness: 3,0mm Cover thickness: 2,0mm 1x Plastic Handwheel MEC/80/A EPDM gasket (FDA) G/T450 Finish Neck: Grinded/Pickled Finish Cover: Electropolished