

## Article properties

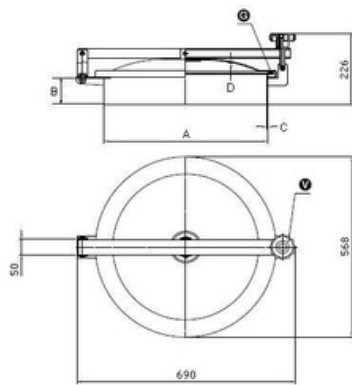

Article	9402.TV500B
Description	Round Manhole Cover TV/500/B Opening outwards: hinge/swivel Material: 1.4404 (316L) Pressure range: pressureless Outside Neck diameter: Ø518mm Tolerance: ISO2768 cL: ±2.0mm Welding Neck height: 100mm Welding Neck thickness: 3,0mm Cover thickness: 3,0mm 1x Plastic Handwheel MEC/80/A EPDM gasket (FDA) G/T500 Finish Neck: Grinded/Pickled Finish Cover: Electropolished TV/500/B (Neck 100x3) 316
Name	TV/500
Type	DN500
DN	518
A	100
B	3
C	3
D	0,0 bar
E	

Round Manhole Cover TV/500/B Opening outwards: hinge/swivel Material: 1.4404 (316L) Pressure range: pressureless Outside Neck diameter: Ø518mm Tolerance: ISO2768 cL: ±2.0mm Welding Neck height: 100mm Welding Neck thickness: 3,0mm Cover thickness: 3,0mm 1x Plastic Handwheel MEC/80/A EPDM gasket (FDA) G/T500 Finish Neck: Grinded/Pickled Finish Cover: Electropolished