

Article properties

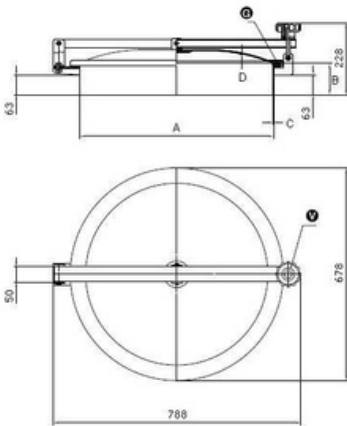

Article	9402.TV600
Description	Round Manhole Cover TV/600 Opening outwards: hinge/swivel Material: 1.4307 (304L) Pressure range: pressureless Outside Neck diameter: Ø620mm Tolerance: ISO2768 cL: ±2.0mm Welding Neck height: 100mm Welding Neck thickness: 3,0mm Cover thickness: 3,0mm 1x Plastic Handwheel MEC/80/A EPDM gasket (FDA) G/T600 Finish Neck: Grinded/Pickled Finish Cover: Electropolished TV/600 (Neck 100x3) 304
Name	TV/600
Type	DN600
DN	620
A	100
B	3
C	3
D	0,0 bar
E	

Round Manhole Cover TV/600 Opening outwards: hinge/swivel Material: 1.4307 (304L) Pressure range: pressureless Outside Neck diameter: Ø620mm Tolerance: ISO2768 cL: ±2.0mm Welding Neck height: 100mm Welding Neck thickness: 3,0mm Cover thickness: 3,0mm 1x Plastic Handwheel MEC/80/A EPDM gasket (FDA) G/T600 Finish Neck: Grinded/Pickled Finish Cover: Electropolished