

Article properties

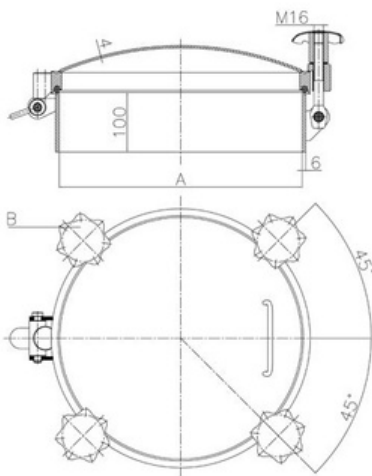

Mangatdeksel is optioneel leverbaar met kijkglas



Article	9405.D25/300B
Description	Fratelli Laveggi cover DN300 Inner welding neck diam.:300mm Mat. wetted parts: 1.4404 Mat. external parts: 1.4301 Working Pressure: -1/+1 bar Temperature: 150° Celsius Gasket: Silicon Temp.range gasket: -50/+200°C Welding neck height: 100mm Welding neck thickness: 6mm Cover thickness: 4mm 4x Stainless steel handwheel M16 Hinge / Grip: Yes / Yes Finish: Ground With PED approval
Name	Manhole D25 NW300 -1/+1 bar 316
Material	1.4404
Type	D25
DN A B	DN300
	300
	4

Fratelli Laveggi cover DN300 Inner welding neck diam.:300mm Mat. wetted parts: 1.4404 Mat. external parts: 1.4301 Working Pressure: -1/+1 bar Temperature: 150° Celsius Gasket: Silicon Temp.range gasket: -50/+200°C Welding neck height: 100mm Welding neck thickness: 6mm Cover thickness: 4mm 4x Stainless steel handwheel M16 Hinge / Grip: Yes / Yes Finish: Ground With PED approval