

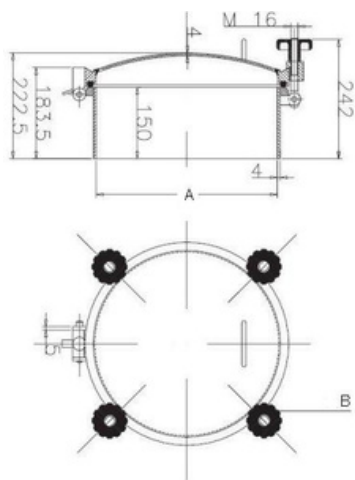

Mangatdeksel is optioneel leverbaar met kijkglas



Article properties

Article	9405.D3/3004
Description	Fratelli Laveggi cover DN300 Inner welding neck diam.: 300mm Mat. wetted parts: 1.4301 Mat. external parts: 1.4301 Working Pressure: -1/+4 bar Temperature: 100° Celsius Gasket: Silicon Temp.range gasket: -50/+200°C Welding neck height: 150mm Welding neck thickness: 4mm Cover thickness: 4mm 4x Plastic handwheel M16 Hinge / Grip: Yes / Yes Finish: Ground Without PED-approval Manhole D3 NW300 -1/+4 bar 304
Name	1.4301
Material	D13
Type	DN300
DN A B	300
	4

Fratelli Laveggi cover DN300 Inner welding neck diam.: 300mm Mat. wetted parts: 1.4301 Mat. external parts: 1.4301 Working Pressure: -1/+4 bar Temperature: 100° Celsius Gasket: Silicon Temp.range gasket: -50/+200°C Welding neck height: 150mm Welding neck thickness: 4mm Cover thickness: 4mm 4x Plastic handwheel M16 Hinge / Grip: Yes / Yes Finish: Ground Without PED-approval