

Article properties

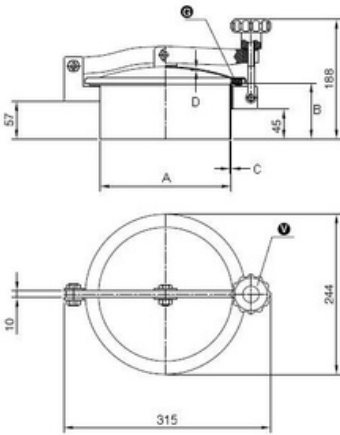

Article	9402.N231 Round Inspection Cover N/231 Cover
Description	opening outwards Material: 1.4307 (304L) Pressure range: +0,5 bar Outside Neck diameter: Ø201mm Tolerance ISO2768 cL: ±1.2mm Welding Neck height: 150mm Welding Neck thickness: 2,0mm Cover thickness: 1,5mm 1x Plastic Handwheel MEC/60 EPDM gasket (FDA)G/T200 Finish Neck: Grinded/Pickled Finish Cover: Electropolished N/231 (Neck 150x2) 304
Name	N/230
Type	DN200
DN	201
A	150
B	2
C	1,5
D	0,5 bar
E	

Round Inspection Cover N/231 Cover opening outwards Material: 1.4307 (304L) Pressure range: +0,5 bar Outside Neck diameter: Ø201mm Tolerance ISO2768 cL: ±1.2mm Welding Neck height: 150mm Welding Neck thickness: 2,0mm Cover thickness: 1,5mm 1x Plastic Handwheel MEC/60 EPDM gasket (FDA)G/T200 Finish Neck: Grinded/Pickled Finish Cover: Electropolished